

IPERCERAMICA
wellness

www.iperceramica.it

This product has been imported by
Bayker Italia S.p.A
Via Ghiarola Nuova, 85/87
41042 Fiorano Modenese (MO) Italy

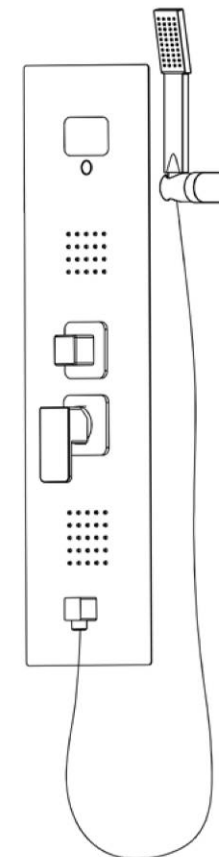
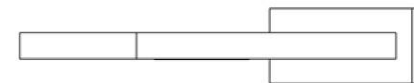

SLIM s/s built-in Shower Panel
(Overhead shower not included)

IPERCERAMICA
wellness
www.iperceramica.it

Installation Guide

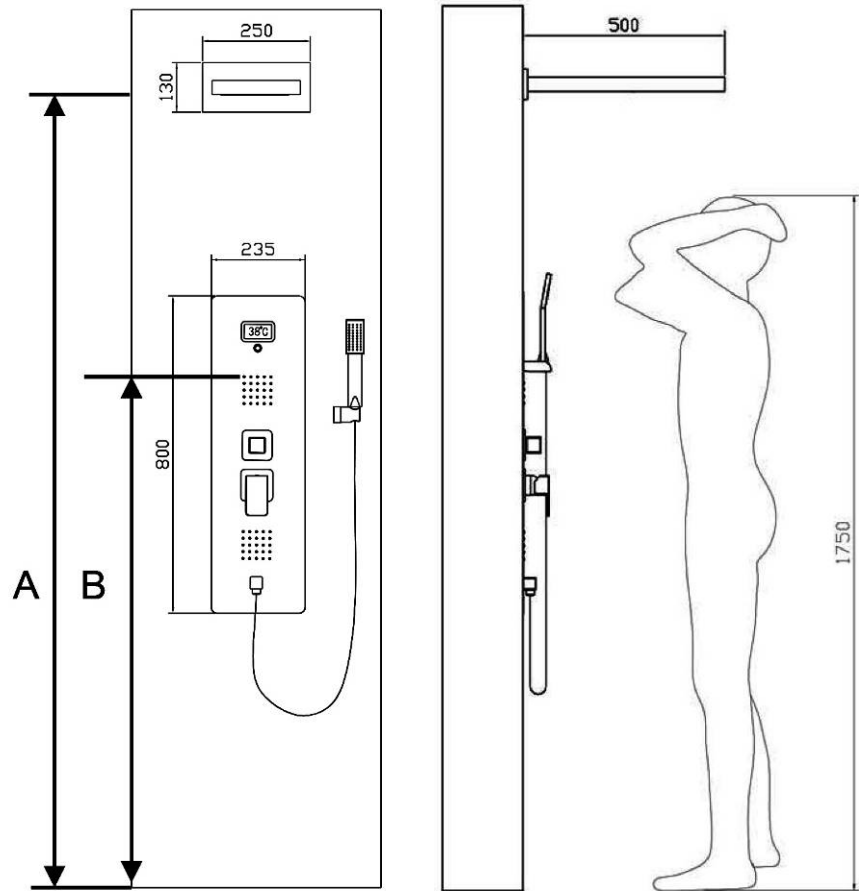

Technical Information

Recommended pressure: 3-5 kg/cm²
 Minimum pressure: 1 kg/cm² = 0.97 atmospheres = 0.981 bar
 Maximum pressure: 6 kg/cm² = 7.26 atmospheres = 7.36 bar

Unit: cm

User Height	A	B
170	200	147
180	210	147
190	220	147

CORRECT Installation position

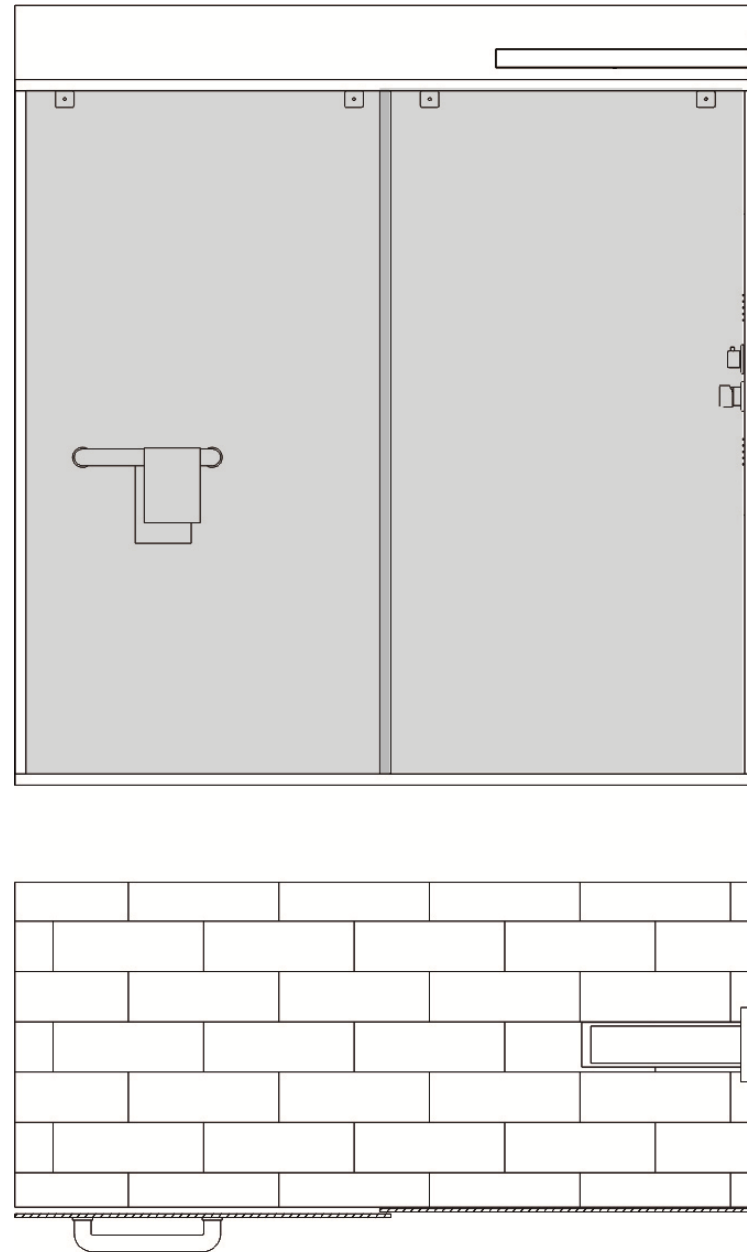

WRONG Installation position

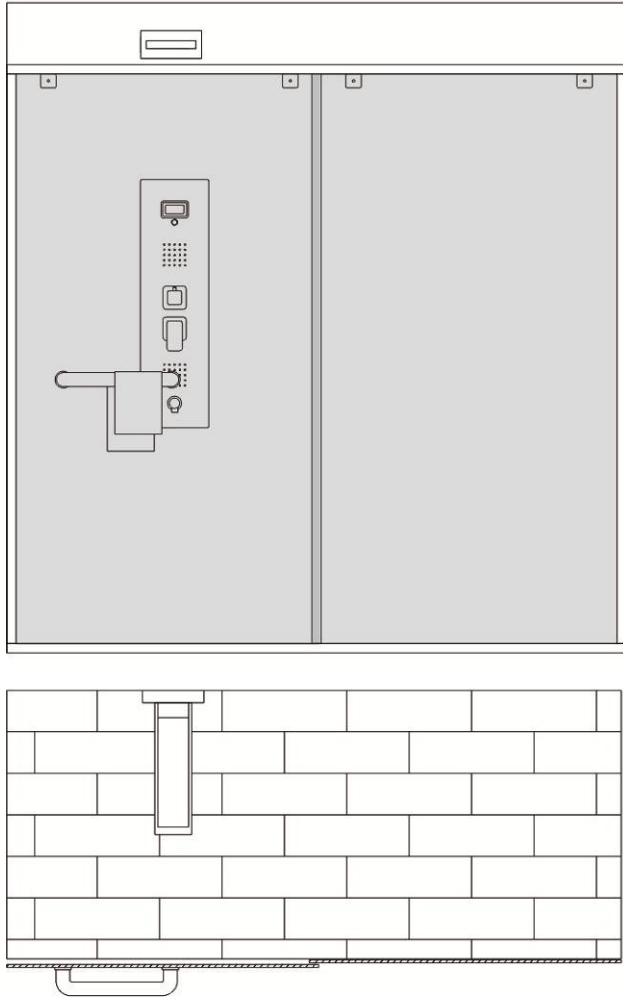

ATTENTION:

Do not install the Shower Panel with water jets in front of a shower enclosure door.

For a correct installation, please install the Shower Panel perpendicularly to the shower door to avoid water spills.

Installation Instruction

1

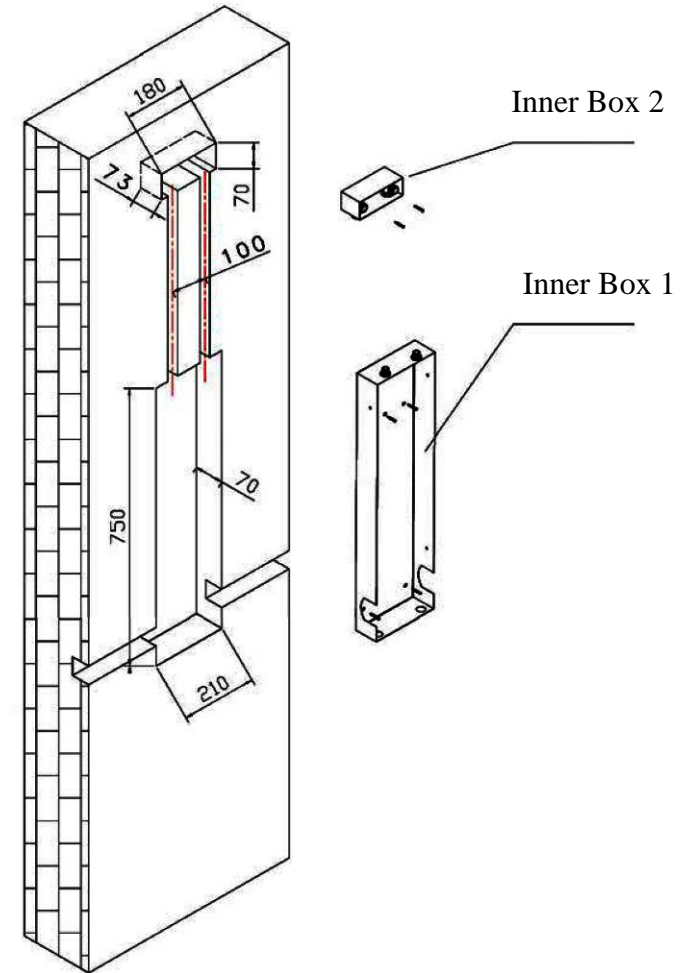

2

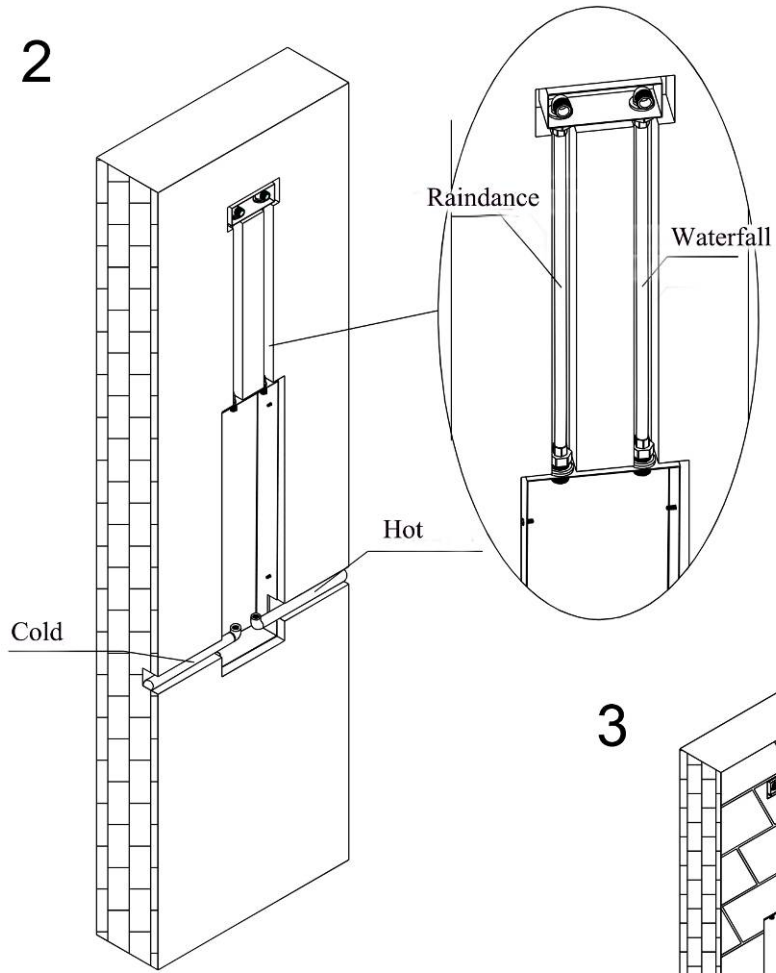

3

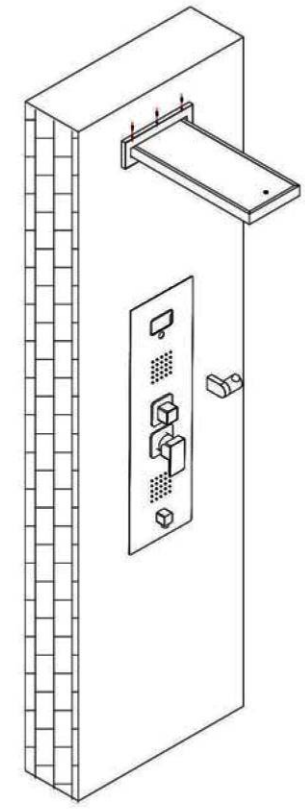
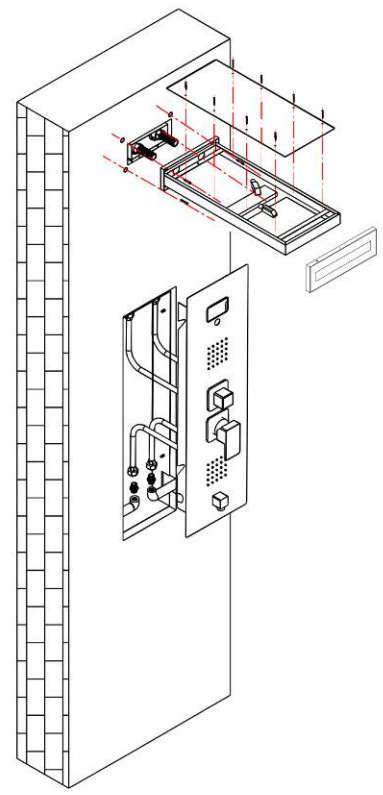
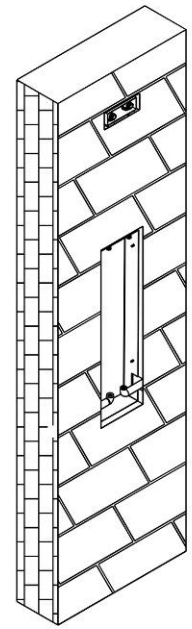

Instructions For Use

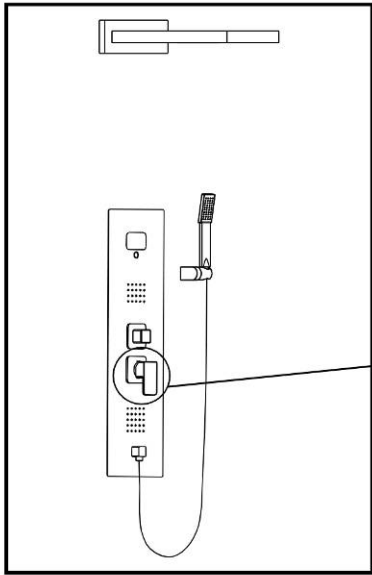

Hot

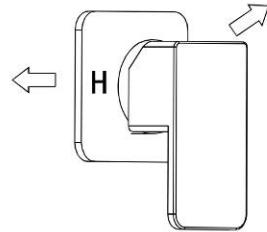

Cold

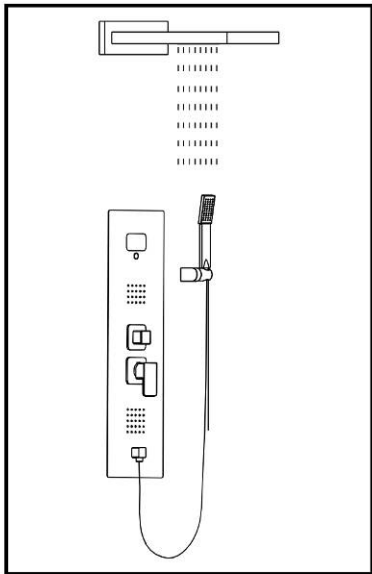
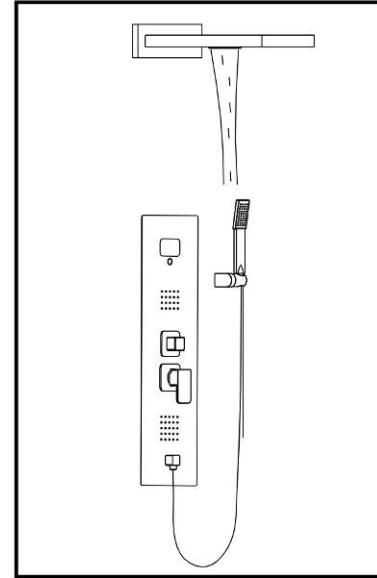

Raindance

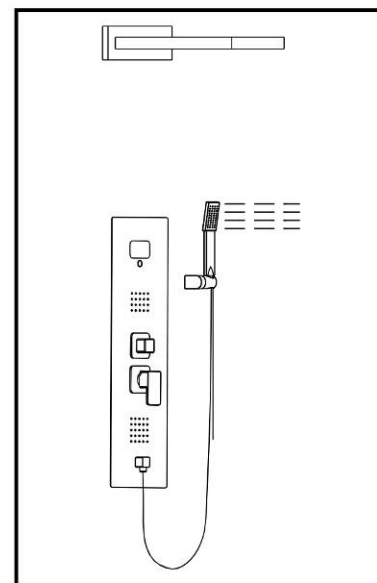
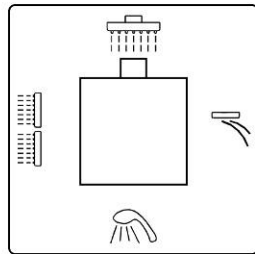

Waterfall

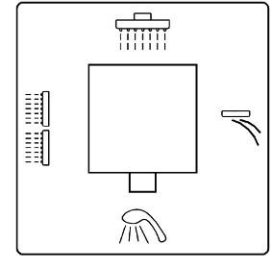

Hand shower

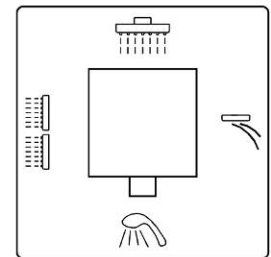

How to change LED indicator battery

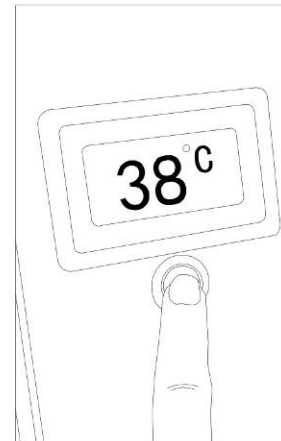
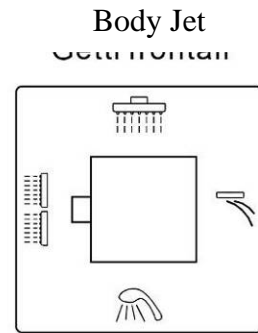
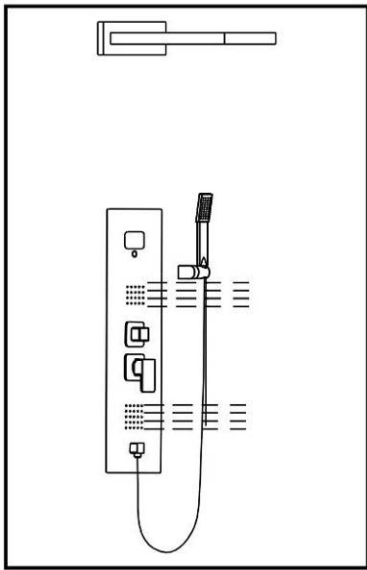

Step 1



Step 2

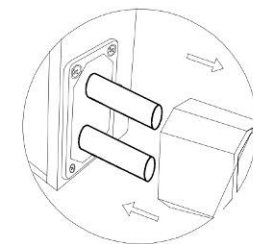

Step 3

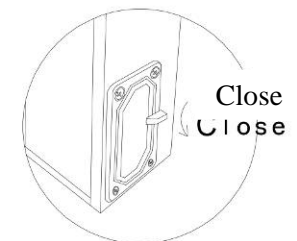

Spare parts:



X1



X1



X1



X6



X6



X2



X2



X1

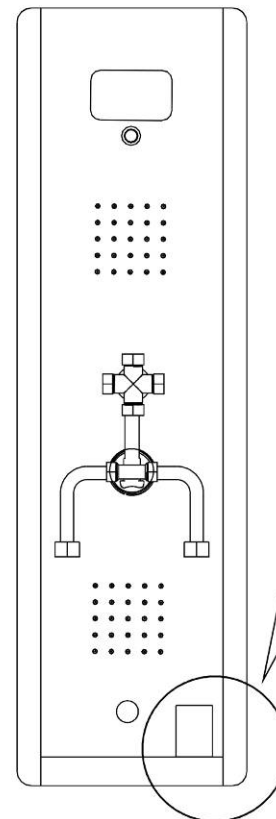

Battery

How to change 4-function to be 3-function

4-function

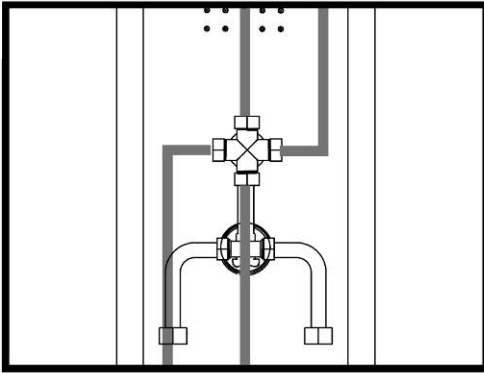

3-function

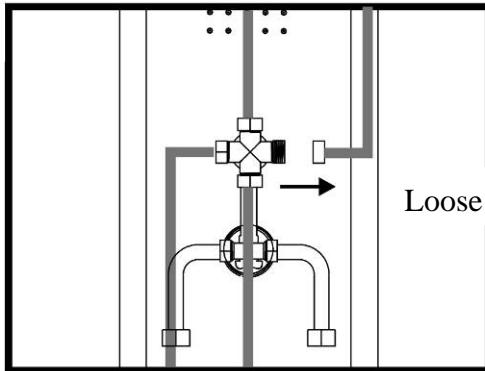

Loose the connected pipe

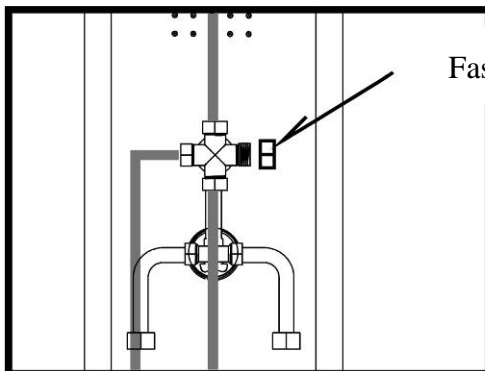

Fasten the brass nut

Care and Maintenance

Using clean water and soft cotton cloth to clean the shower panel.

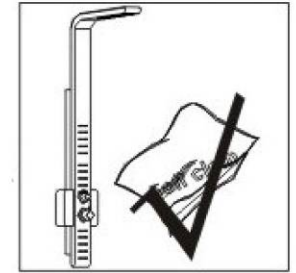

Not using cleaning powder, chemical detergent to clean the shower panel.



Not using acidic detergent to clean the shower panel.



Not pulling the shower hose forcibly in order to avoid the hose cracks.

