

IPERCERAMICA
wellness

www.iperceramica.it

Prodotto importato da:

BayKer Italia S.p.A

Via Pedemontana 13-41042

Fiorano Modenese(MO)-ITALY

www.iperceramica.it

MADE IN P.R.C

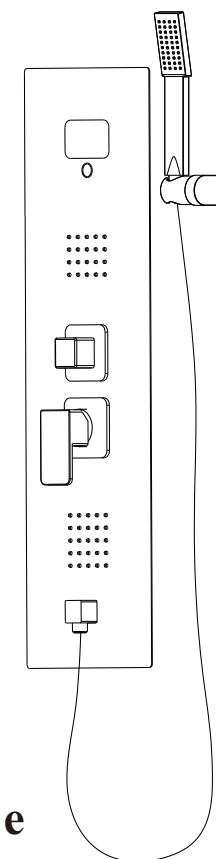
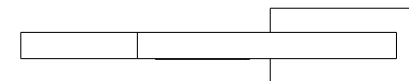

SLIM INOX
Pannello Doccia Multifunzione
(Soffione doccia non incluso)

IPERCERAMICA
wellness

www.iperceramica.it

Guida all'installazione

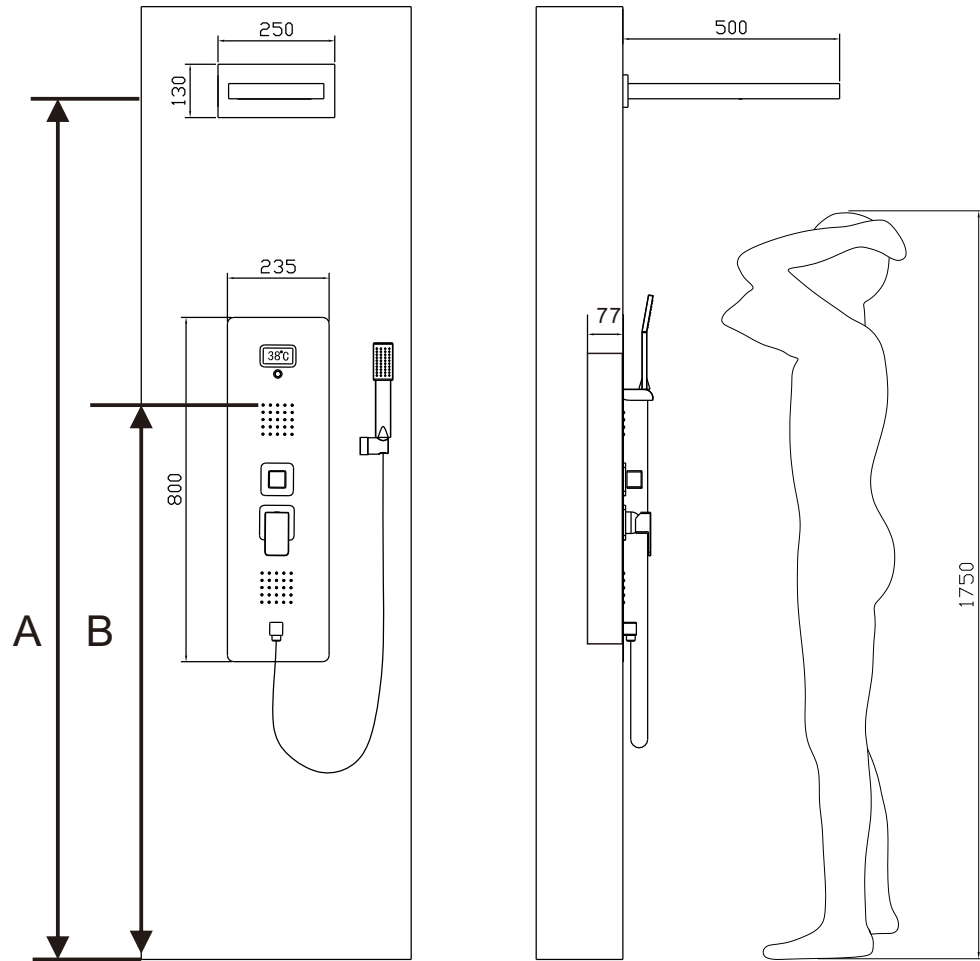

Informazioni Tecniche

Pressione consigliata: 2-5 kg/cm²
 Pressione minima: 1kgf/cm² = 0.981 atmosfere = 0.981bar
 Pressione massima: 7.5kg/cm² = 7.26 atmosfere = 7.36bar

Unit:CM

Altezza utilizzatore	A	B
170	200	147
180	210	147
190	220	147

Intallazione Coretta

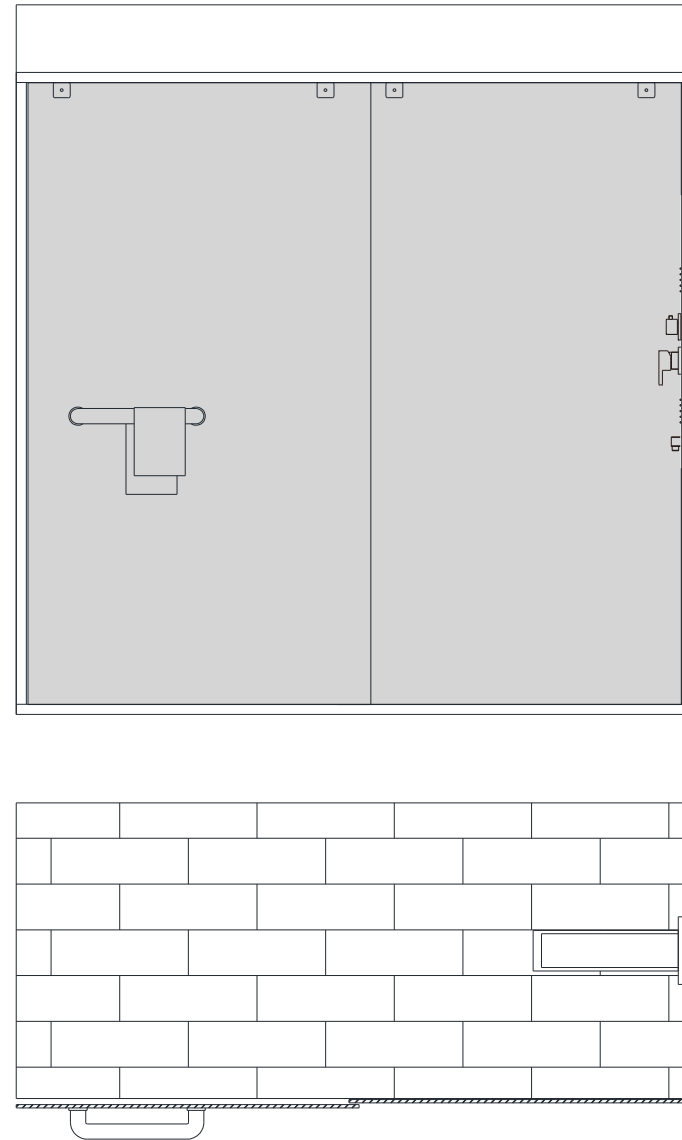

Installazione Sconsigliata

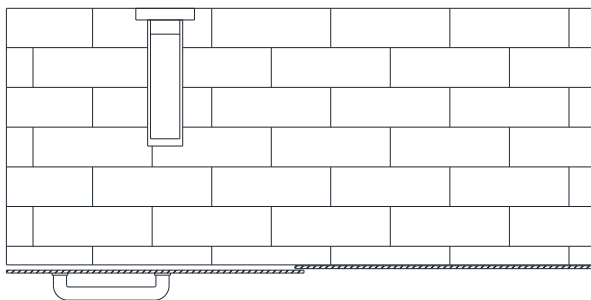
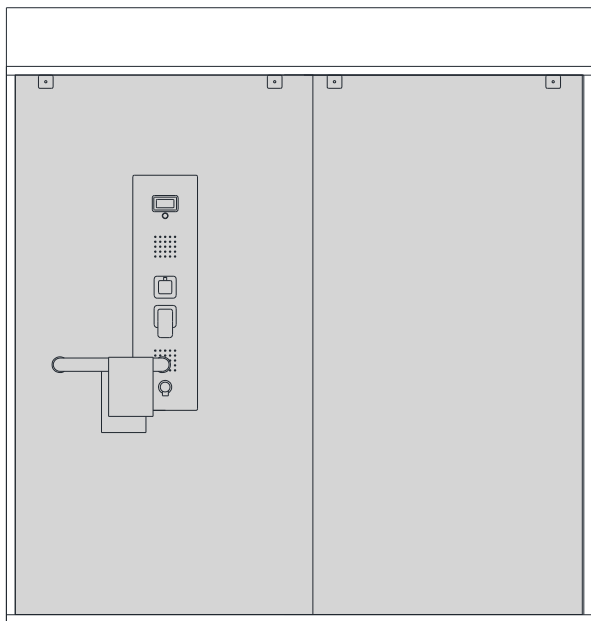

ATTENZIONE:

Per un'installazione corretta di un Pannello Doccia multifunzione con getti idromassaggio, si sconsiglia l'installazione del Pannello Doccia sulla parete frontale rispetto alla porta del box doccia.

L'installazione corretta del Pannello Doccia deve essere eseguita sul lato della parete perpendicolare alla porta del box doccia per evitare fuoriuscite d'acqua.

Istruzioni di installazione

1

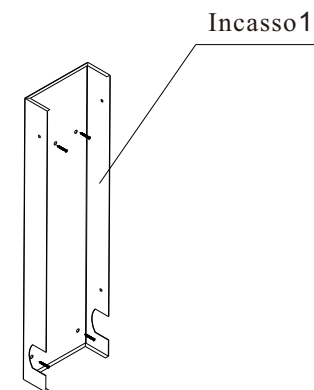
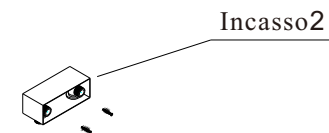
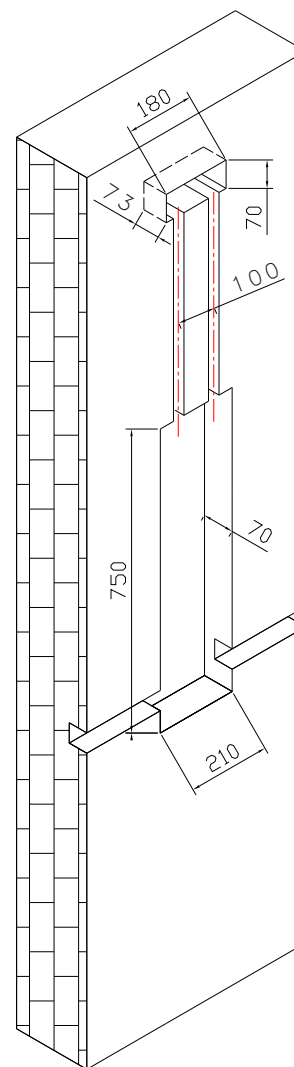

2

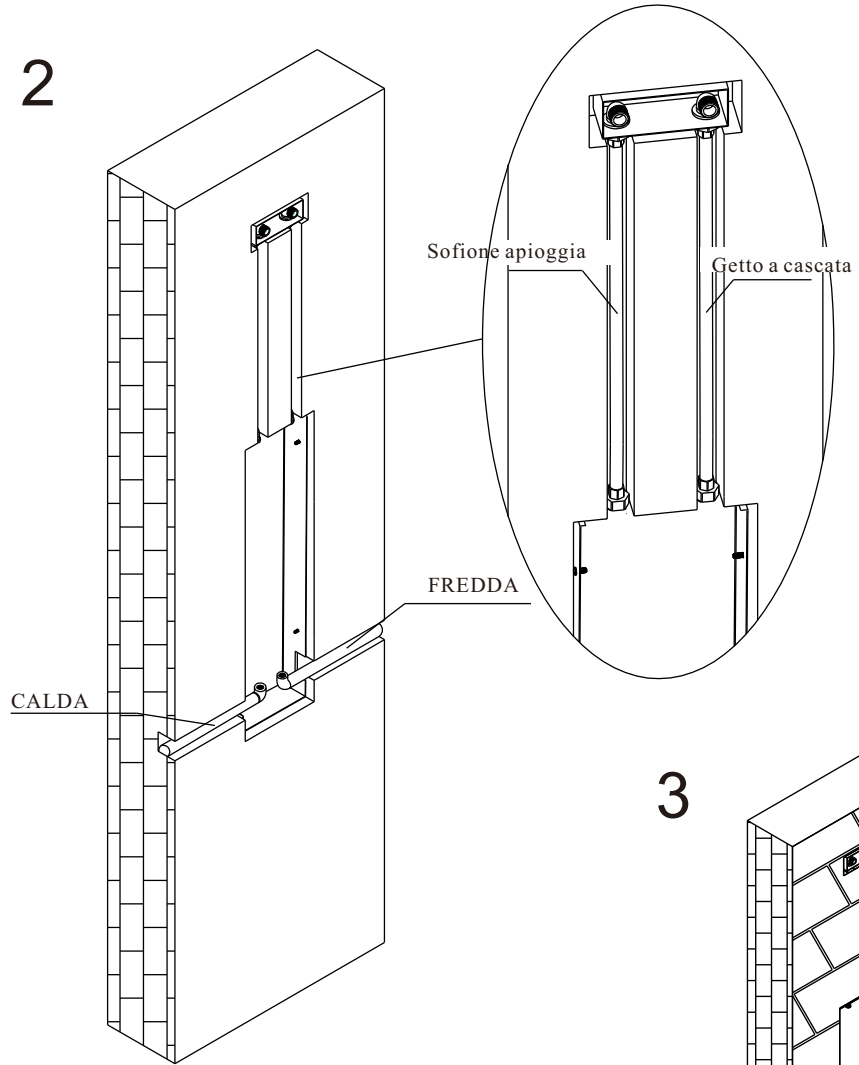

3

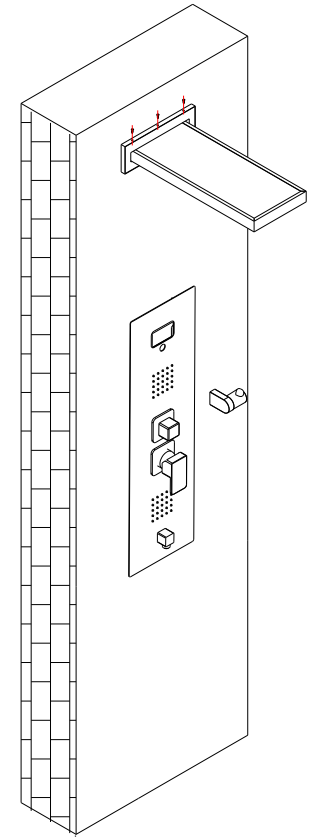
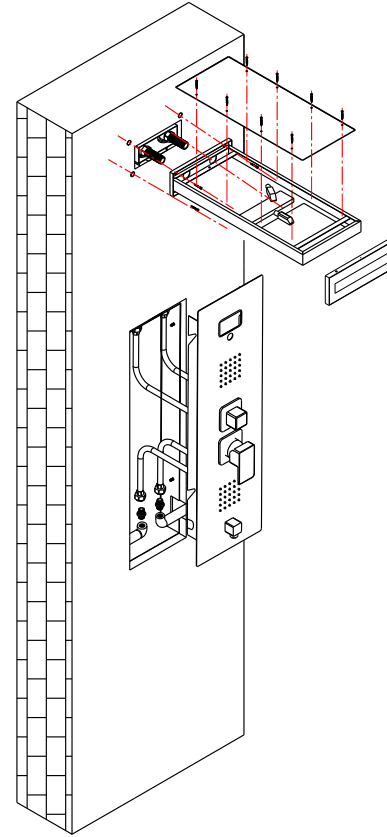
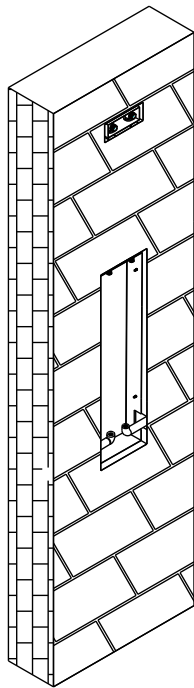

5

6

Istruzioni d'uso

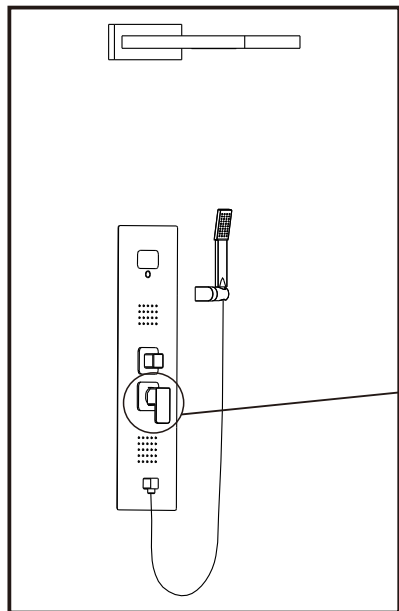

CALDA

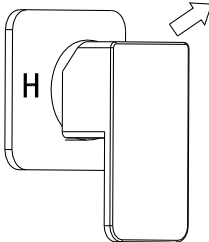

FREDDA

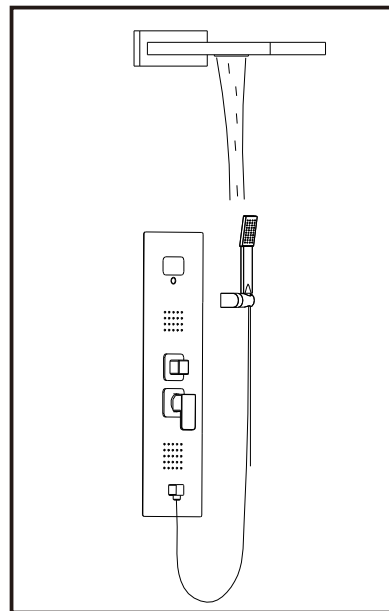

Getto a cascata

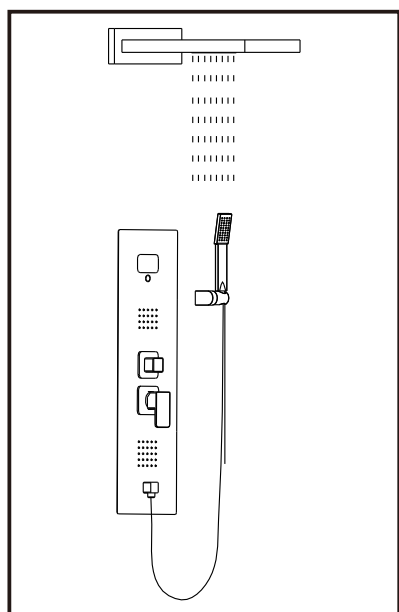
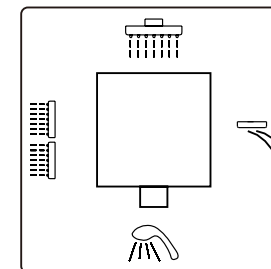

Soffione a pioggia

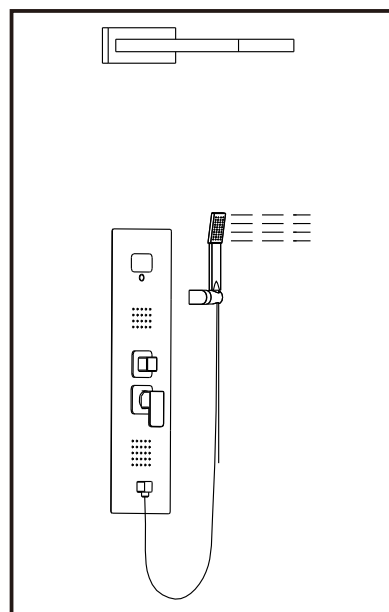
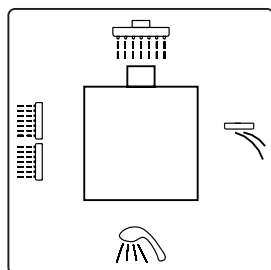

Doccetta a stilo

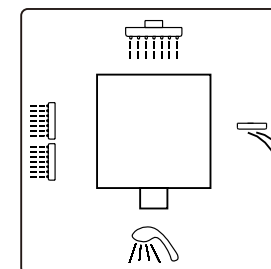

Cambiare la batteria del display a LED

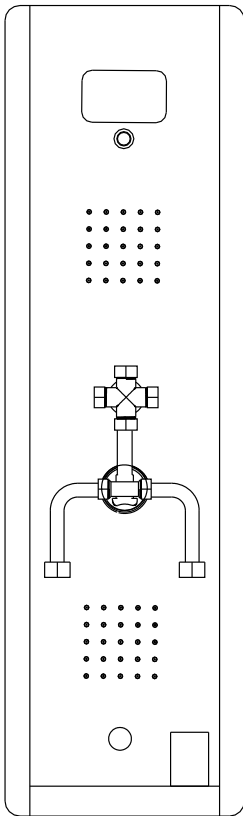
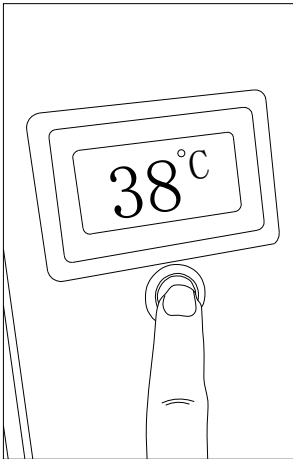
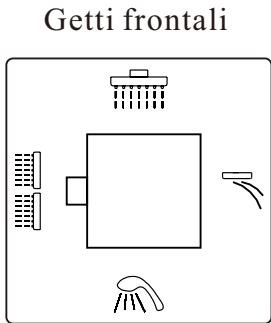
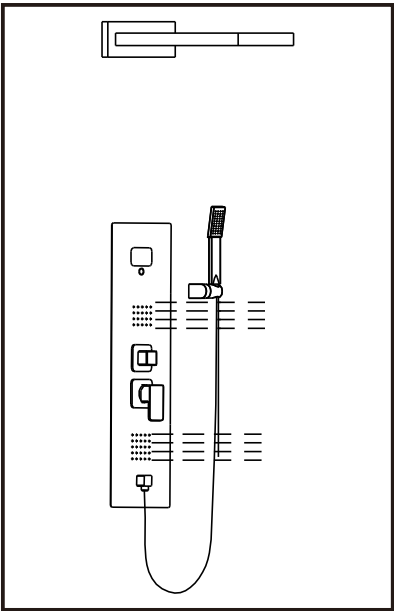

Batteria

Step 1

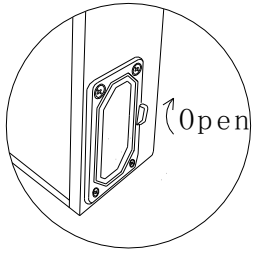

Step 2

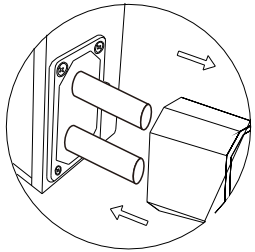

Step 3

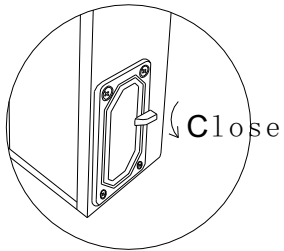

X1



X1



X1



X6



X6



X2



X2



X1

4-funzioni

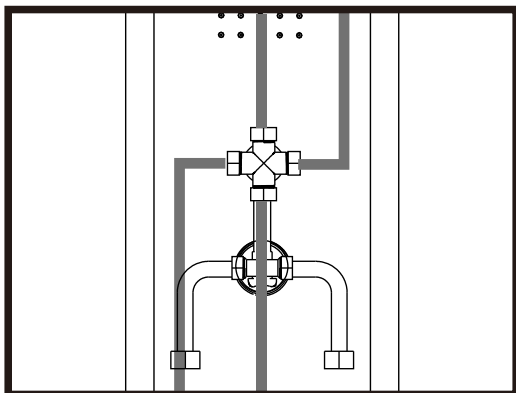

3-funzioni

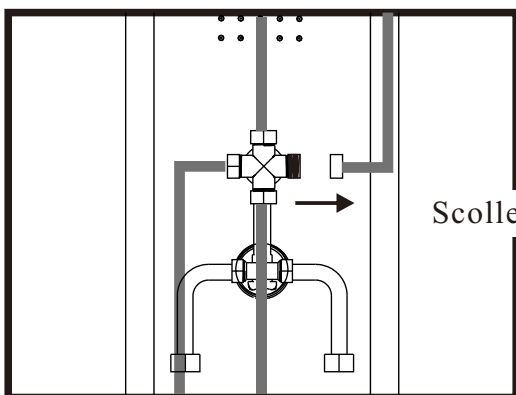

Scollegare il tubo

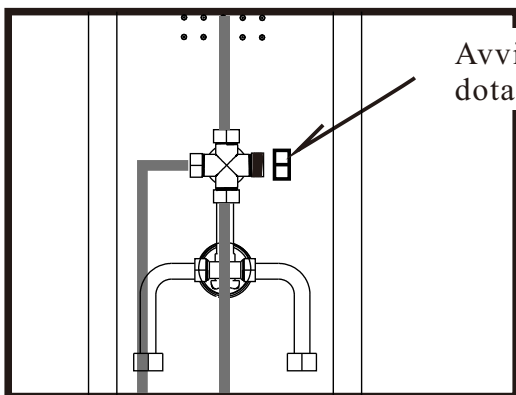

Avvitare il tappo in dotazione

Cura e mantenimento

Per pulire il pannello doccia utilizzare acqua pulita e un tessuto di cotone morbido e non abrasivo.

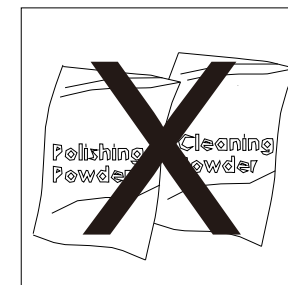

Non utilizzare detersivi in polvere o chimici per la pulizia.

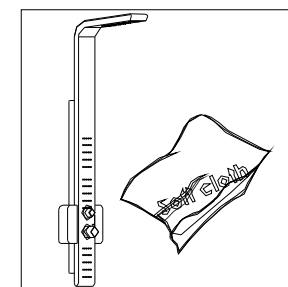

Non utilizzare detersivi acidi per la pulizia.

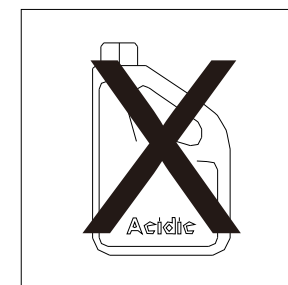

Non utilizzare spazzole di nylon per la pulizia.

