

✉ info@omp tea.com
🌐 omp tea.eu
omp tea-floordrain.eu

📍 via XI Febbraio 18
25065 Lumezzane (BS)
Italia

☎ +39 0365 897941
📠 +39 0365 897940

Articolo

[mm]





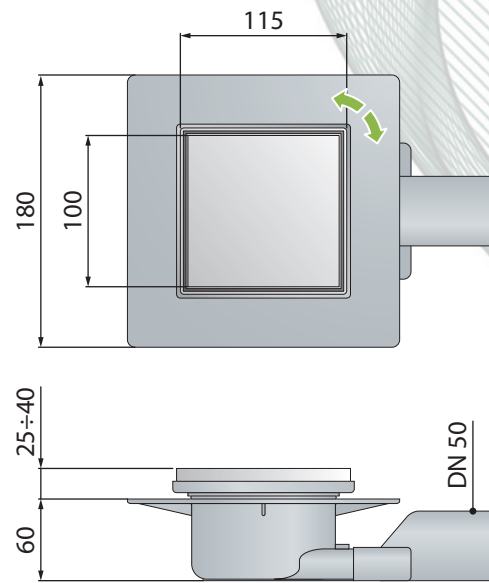

15962

Piletta sifoide in ABS per scarico pavimento:

- griglia piastrellabile in acciaio inox AISI316 regolabile in altezza per pavimenti con spessore da 25 a 40 mm
- cornice quadra orientabile in acciaio inox AISI316 115×115
- uscita laterale DN50
- flangia per predisposizione all'impermeabilizzazione a letto sottile
- ispezionabile
- ridotto ingombro sottotraccia 60 mm



Specifiche

-  Chiusura idraulica
35 mm
-  Portata d'acqua
24 l/min
-  Materiale
ABS ed ottone cromato
-  Misure
115×115 - DN50
-  Peso
760 g/pezzo
-  Imballaggio
in scatola singola, 10 pezzi/cartone standard

Nomenclatura doganale
39173900