

*Collection*

**ATLAS**

**IPER♦CERAMICA**



Idee compositive

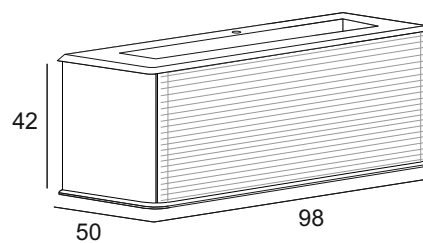
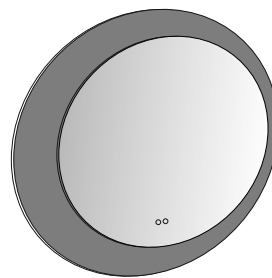
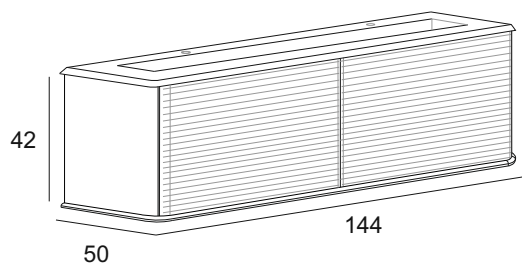
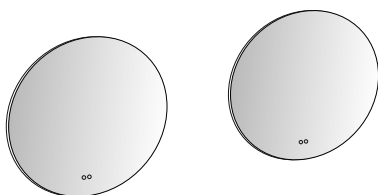
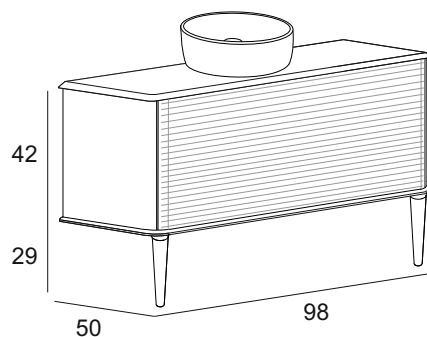
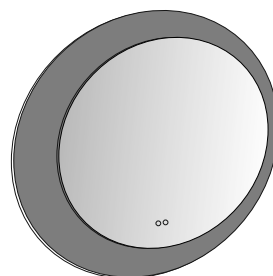
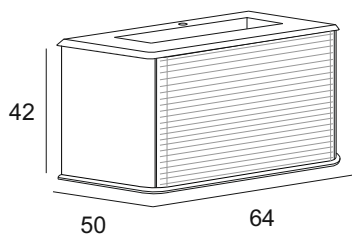
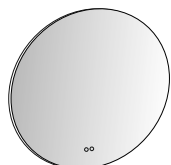

**NB: Le misure riportate sono puramente indicative.  
Eventuali differenze di +/- 10 mm dovute anche ad esigenze produttive NON precludono la conformità o funzionalità del prodotto.  
Verificare le quote con il mobile prima di realizzare gli scarichi.**

|  |   |   |   |  |   |
|--|---|---|---|--|---|
| <b>Bianco opaco</b><br>Matt white<br>Weiss matt<br>Blanc mat | <b>Cotone</b><br>Cotton<br>Baumwolle<br>Coton | <b>Verde opaco</b><br>Matt green<br>Dunkelgrün matt<br>Vert mat | <b>Nero opaco</b><br>Matt black<br>Schwarz matt<br>Noir mat | <b>Rovere Tabacco</b><br>Tobacco Oak<br>Tabak Eiche<br>Chêne Tabac | <b>Noce</b><br>Walnut<br>Walnuss<br>Noyer |
|--|---|---|---|--|---|

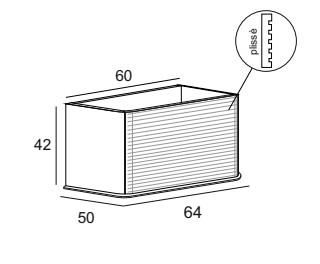

Base lavabo con un cassetto chiusura ammortizzata e apertura push , guida in metallo , due divisori in vetro , finitura interna nero.  
Base unit with one drawer with soft-closing system and push opening, metal drawer slides, two glass dividers, black internal finish.  
Waschtischunterschrank mit einer Schublade, Drucköffnung und Soft Schliessung, Metallzargen, 2 Glasfächer schwarz satiniert.  
Sous-vasque avec un tiroir fermeture freinée et ouverture push, glissière en métal, deux séparateurs en verre, finition interne noire.

**Ref: 75505 Ref: 75506 Ref: 75507 Ref: 75508 Ref: 75509 Ref: 75510**

8003964557988 8003964557995 8003964558008 8003964558015 8003964558039 8003964558022

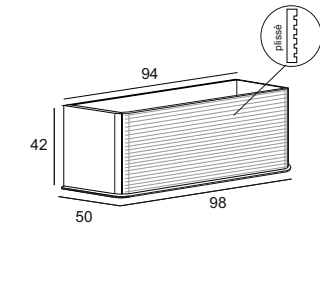

Base lavabo con un cassetto chiusura ammortizzata e apertura push , guida in metallo , tre divisori in vetro , finitura interna nero.  
Base unit with one drawer with soft-closing system and push opening, metal drawer slides, three glass dividers, black internal finish.  
Waschtischunterschrank mit einer Schublade, Drucköffnung und Soft Schliessung, Metallzargen, 3 Glasfächer schwarz satiniert.  
Sous-vasque avec un tiroir fermeture freinée et ouverture push, glissière en métal, trois séparateurs en verre, finition interne noire

**Ref: 75511 Ref: 75512 Ref: 75513 Ref: 75514 Ref: 75515 Ref: 75516**

8003964558046 8003964558053 8003964558060 8003964558077 8003964558091 8003964558084

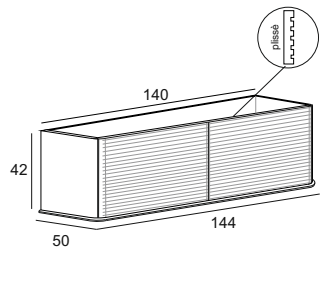

Base lavabo con due cassetti chiusura ammortizzata e apertura push , guida in metallo , quattro divisori in vetro , finitura interna nero.  
Base unit with two drawers with soft-closing system and push opening, metal drawer slides, four glass dividers, black internal finish.  
Waschtischunterschrank mit 2 Schubladen, Drucköffnung und Soft Schliessung, Metallzargen, 4 Glasfächer schwarz satiniert, Innenverarbeitung schwarz.  
Sous-vasque avec deux tiroirs fermeture freinée et ouverture push, glissière en métal, quatre séparateurs en verre, finition interne noire.

**Ref: 75517 Ref: 75518 Ref: 75519 Ref: 75520 Ref: 75521 Ref: 75522**

8003964558107 8003964558114 8003964558121 8003964558138 8003964558152 8003964558145

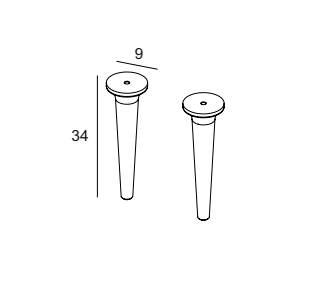

Set due piedi in legno massello per base con lavabo d'appoggio.  
Set of two feet in solid wood for base unit with countertop washbasin.  
Set 2 Füße in Massivholz für Waschtischunterschrank mit Aufsatz Waschbecken.  
Set de deux pieds en bois massif pour sous-vasque avec vasque à pose.

**Ref: 75523 Ref: 75524 Ref: 75525 Ref: 75526 Ref: 75527 Ref: 75528**

8003964404343 8003964404350 8003964404367 8003964404374 8003964404398 8003964404381

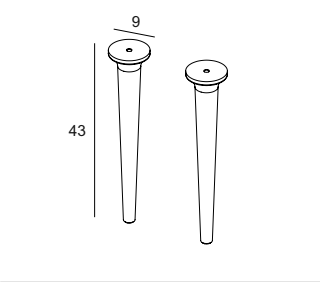

Set due piedi in legno massello per base con lavabo integrale.  
Set of two feet in solid wood for base unit with integrated washbasin.  
Set 2 Füße in Massivholz für Waschtischunterschrank mit integriertem Waschbecken.  
Set de deux pieds en bois massif pour sous-vasque avec vasque intégré.

**Ref: 75529 Ref: 75530 Ref: 75531 Ref: 75532 Ref: 75533 Ref: 75534**

8003964404435 8003964404442 8003964404459 8003964404466 8003964404480 8003964404473

**NB: Le misure riportate sono puramente indicative.**  
**Eventuali differenze di +/- 10 mm dovute anche ad esigenze produttive NON precludono la conformità o funzionalità del prodotto.**  
**Verificare le quote con il mobile prima di realizzare gli scarichi.**

## Lavabo in resina

Resin washbasin  
Waschbecken in Mineralguss  
Vasque en résine

**Bianco opaco**  
Matt white  
Weiss matt  
Blanc mat

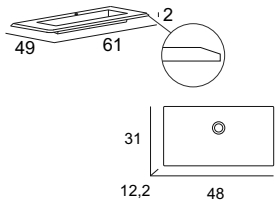

Lavabo in resina con vasca centrale.  
Resin washbasin with central sink.  
Waschtisch in Mineralguss mit zentralem Becken.  
Lavabo en résine avec vasque centrée.

**Ref: 75535**

8003964503527

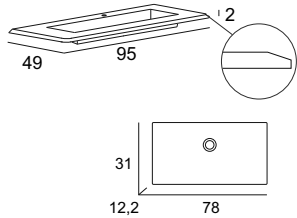

Lavabo in resina con vasca centrale.  
Resin washbasin with central sink.  
Waschtisch in Mineralguss mit zentralem Becken.  
Lavabo en résine avec vasque centrée.

**Ref: 75536**

8003964502643

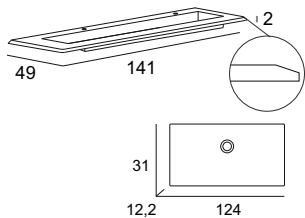

Lavabo in resina con vasca centrale.  
Resin washbasin with central sink.  
Waschtisch in Mineralguss mit zentralem Becken.  
Lavabo en résine avec vasque centrée.

**Ref: 75537**

8003964502650

## Lavabo d'appoggio

Countertop washbasin  
Aufsatz Waschbecken  
Vasque à poser

**Bianco lucido**  
Glossy white  
Weiss hochglanz  
Blanc brillant

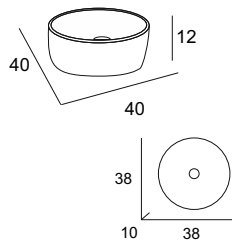

Lavabo in ceramica per top d'appoggio.  
Ceramic washbasin for top.  
Aufsatz Keramikbecken für Variante mit Top in MDF.  
Lavabo en céramique pour top d'appui.

**Ref: 75538**

8003964501004

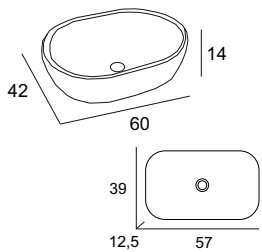



Lavabo in ceramica per top d'appoggio.  
Ceramic washbasin for top.  
Aufsatz Keramikbecken für Variante mit Top in MDF.  
Lavabo en céramique pour top d'appui.

**Ref: 67528**

8003964501790

**NB: Le misure riportate sono puramente indicative.**  
Eventuali differenze di +/- 10 mm dovute anche ad esigenze produttive NON precludono la conformità o funzionalità del prodotto.  
Verificare le quote con il mobile prima di realizzare gli scarichi.

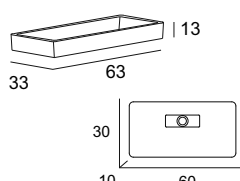

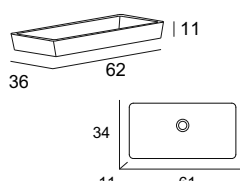
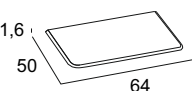
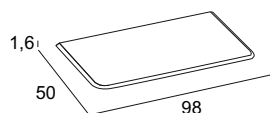
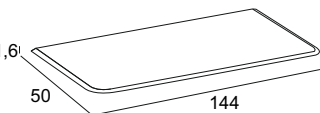
|   |  |   |   |  |   |   |
|---|--|---|---|--|---|---|
| <b>Lavabo d'appoggio</b><br>Countertop washbasin<br>Aufsatz Waschbecken<br>Vasque à poser | <b>Bianco opaco</b><br>Matt white<br>Weiss matt<br>Blanc mat   |   | <b>Nero opaco</b><br>Matt black<br>Schwarz matt<br>Noir mat     |  |   |   |
|           | Lavabo in solid surface per top d'appoggio.<br>Solid surface washbasin for top.<br>Waschtisch in Solid Surface für Variante mit Top in MDF.<br>Lavabo en solid surface pour top d'appui. |   |   |  |   |   |
| <b>Ref: 75539</b><br><br>8003964501844  |  | <b>Ref: 75540</b><br><br>8003964502070                          |   |  |  |   |
| <b>Lavabo d'appoggio</b><br>Countertop washbasin<br>Aufsatz Waschbecken<br>Vasque à poser | <b>Bianco opaco</b><br>Matt white<br>Weiss matt<br>Blanc mat   | <b>Verde opaco</b><br>Matt green<br>Dunkelgrün matt<br>Vert mat | <b>Nero opaco</b><br>Matt black<br>Schwarz matt<br>Noir mat     | <b>Blu petrolio</b><br>Petrol blue<br>Ölblau<br>Bleu pétrole | <b>Grigio nuvola</b><br>Gray cloud<br>Hellgrau<br>Gris nuage                        |   |
|           | Lavabo in ceramica per top d'appoggio.<br>Ceramic washbasin for top.<br>Aufsatz Keramikbecken für Variante mit Top in MDF.<br>Lavabo en céramique pour top d'appui.                      |   |   |  |   |   |
| <b>Ref: 75541</b><br><br>8003964503350  |  | <b>Ref: 75542</b><br><br>8003964503374                          | <b>Ref: 75543</b><br><br>8003964503367                          | <b>Ref: 75544</b><br><br>8003964503398                       | <b>Ref: 75545</b><br><br>8003964503381  |   |
| <b>Top in legno</b><br>Wooden top<br>Top in MDF<br>Top en bois                            | <b>Bianco opaco</b><br>Matt white<br>Weiss matt<br>Blanc mat   | <b>Cotone</b><br>Cotton<br>Baumwolle<br>Coton                   | <b>Verde opaco</b><br>Matt green<br>Dunkelgrün matt<br>Vert mat | <b>Nero opaco</b><br>Matt black<br>Schwarz matt<br>Noir mat  | <b>Rovere Tabacco</b><br>Tobacco Oak<br>Tabak Eiche<br>Chêne Tabac                  | <b>Noce</b><br>Walnut<br>Walnuss<br>Noyer |
|         | Top in legno per lavabo d'appoggio.<br>Wooden top for countertop washbasin.<br>Top in MDF.<br>Top en bois pour vasque à poser.   |   |   |  |   |   |
| <b>Ref: 75546</b><br><br>8003964558251  |  | <b>Ref: 75547</b><br><br>8003964558268                          | <b>Ref: 75548</b><br><br>8003964558275                          | <b>Ref: 75549</b><br><br>8003964558282                       | <b>Ref: 75550</b><br><br>8003964558305  | <b>Ref: 75551</b><br><br>8003964558299    |
|         | Top in legno per lavabo d'appoggio.<br>Wooden top for countertop washbasin.<br>Top in MDF.<br>Top en bois pour vasque à poser.   |   |   |  |   |   |
| <b>Ref: 75552</b><br><br>8003964558312  |  | <b>Ref: 75553</b><br><br>8003964558329                          | <b>Ref: 75554</b><br><br>8003964558336                          | <b>Ref: 75555</b><br><br>8003964558343                       | <b>Ref: 75556</b><br><br>8003964558367  | <b>Ref: 75557</b><br><br>8003964558350    |
|         | Top in legno per lavabo d'appoggio.<br>Wooden top for countertop washbasin.<br>Top in MDF.<br>Top en bois pour vasque à poser.   |   |   |  |   |   |
| <b>Ref: 75558</b><br><br>8003964558374  |  | <b>Ref: 75559</b><br><br>8003964558381                          | <b>Ref: 75560</b><br><br>8003964558398                          | <b>Ref: 75561</b><br><br>8003964558404                       | <b>Ref: 75562</b><br><br>8003964558428  | <b>Ref: 75563</b><br><br>8003964558411    |

**NB: Le misure riportate sono puramente indicative.**

**Eventuali differenze di +/- 10 mm dovute anche ad esigenze produttive NON precludono la conformità o funzionalità del prodotto.**

**Verificare le quote con il mobile prima di realizzare gli scarichi.**

## Complementi

Accessories  
Bausteine/Zubehör  
Compléments

**Bianco opaco**  
Matt white  
Weiss matt  
Blanc mat

**Nero opaco**  
Matt black  
Schwarz matt  
Noir mat

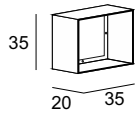

Pensile in metallo.  
Metal wall unit.  
Metall Hängeschrank.  
Cube mural en métal.

**Ref: 75564**

**Ref: 24082**

8003964404169

8003964403865

## Complementi

Accessories  
Bausteine/Zubehör  
Compléments

**Bianco opaco**  
Matt white  
Weiss matt  
Blanc mat

**Cotone**  
Cotton  
Baumwolle  
Coton

**Verde opaco**  
Matt green  
Dunkelgrün matt  
Vert mat

**Nero opaco**  
Matt black  
Schwarz matt  
Noir mat

**Rovere Tabacco**  
Tobacco Oak  
Tabak Eiche  
Chêne Tabac

**Noce**  
Walnut  
Walnuss  
Noyer

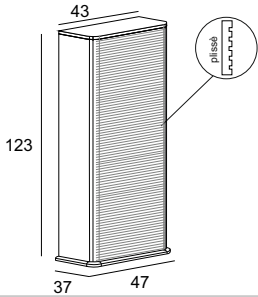

Colonna con un'anta , chiusura ammortizzata , due ripiani in legno, finitura interna nero.  
Cupboard with one door, soft-closing system, two wooden shelves, black internal finish.  
Hochschrank mit Tür, Soft Schliessung, 2 Ablagen in MDF, Innenverarbeitung schwarz.  
Colonne à une porte, fermeture freinée, deux étagères en bois, finition interne noire.

**Ref: 75565** **Ref: 75566** **Ref: 75567** **Ref: 75568** **Ref: 75569** **Ref: 75570**

8003964558169 8003964558176 8003964558183 8003964558190 8003964558213 8003964558206

Set due piedi in legno massello per colonna.  
Set of two solid wood feet for cupboard.  
Set 2 Füße in Massivholz für Hochschrank.  
Set de deux pieds en bois massif pour colonne.

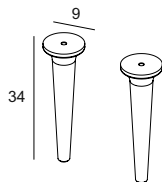

**Ref: 75523** **Ref: 75524** **Ref: 75525** **Ref: 75526** **Ref: 75527** **Ref: 75528**

8003964404343 8003964404350 8003964404367 8003964404374 8003964404398 8003964404381

Colonna con un'anta, chiusura ammortizzata con quattro ripiani in vetro ed uno in legno, finitura interna nero.  
Cupboard with one door, soft closing with four glass shelves and one in wood, black interior finish.  
Hochschrank, 1-türig soft, 4x Glasfächer, 1x Holzfach, Innenverarbeitung schwarz.  
Colonne avec une porte, fermeture freinée avec quatre tablettes en verre et une en bois, finition interne noire.

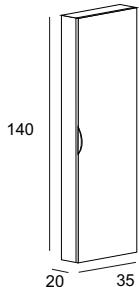

**Ref: 67570** **Ref: 75571** **Ref: 75572** **Ref: 75573** **Ref: 75574** **Ref: 75575**

8003964551795 8003964558237 8003964552976 8003964558220 8003964555397 8003964558244

**NB: Le misure riportate sono puramente indicative.**

**Eventuali differenze di +/- 10 mm dovute anche ad esigenze produttive NON precludono la conformità o funzionalità del prodotto.**

**Verificare le quote con il mobile prima di realizzare gli scarichi.**

# Specchi

Mirrors  
Spiegel  
Miroirs

Neutro  
Neutral  
Neutral  
Neutre

47  
3 47

Specchio con schienale rigido, illuminazione a led e accensione e dimmer luce calda/fredda.  
Mirror with wooden back and LED lighting with touch switch and hot/cold light dimmer.  
Spiegel mit Holzuntergrund Konstruktion, LED Beleuchtung mit EIN/AUS Funktion, dimmbar, Lichtdimmer warmweiss/kaltweiss.  
Miroir avec dos rigide et éclairage led avec allumage et dimmer lumière chaude/froide tactil.

Ref: 75576

8003964451002



80  
3 80

Specchio con schienale rigido, illuminazione a led e accensione e dimmer luce calda/fredda.  
Mirror with wooden back and LED lighting with touch switch and hot/cold light dimmer.  
Spiegel mit Holzuntergrund Konstruktion, LED Beleuchtung mit EIN/AUS Funktion, dimmbar, Lichtdimmer warmweiss/kaltweiss.  
Miroir avec dos rigide et éclairage led avec allumage et dimmer lumière chaude/froide tactil.

Ref: 75577

8003964451019



104  
3 104

Specchio con schienale rigido, illuminazione a led e accensione e dimmer luce calda/fredda.  
Mirror with wooden back and LED lighting with touch switch and hot/cold light dimmer.  
Spiegel mit Holzuntergrund Konstruktion, LED Beleuchtung mit EIN/AUS Funktion, dimmbar, Lichtdimmer warmweiss/kaltweiss.  
Miroir avec dos rigide et éclairage led avec allumage et dimmer lumière chaude/froide tactil.

Ref: 75578

8003964451026



60  
5 60

Cornice in Plexiglass diam. 60cm.

**Nero opaco**  
Matt black  
Schwarz matt  
Noir mate

**Bianco opaco**  
Matt white  
Weiss matt  
Blanc mate

**Ambra**  
Amber  
Bernstein  
Ambre

Ref: 75579

8003964451040

Ref: 75580

8003964451033

Ref: 75581

8003964451057



94  
5 94

Cornice in Plexiglass diam. 94cm.

Ref: 75582

8003964451071

Ref: 75583

8003964451064

Ref: 75584

8003964451088



117  
5 117

Cornice in Plexiglass diam. 117cm.

Ref: 75585

8003964451101

Ref: 75586

8003964451095

Ref: 75587

8003964451118



**NB: Le misure riportate sono puramente indicative.**

**Eventuali differenze di +/- 10 mm dovute anche ad esigenze produttive NON precludono la conformità o funzionalità del prodotto.**

**Verificare le quote con il mobile prima di realizzare gli scarichi.**



Misure indicative

LINEA IDRA

61 - 95cm

141cm

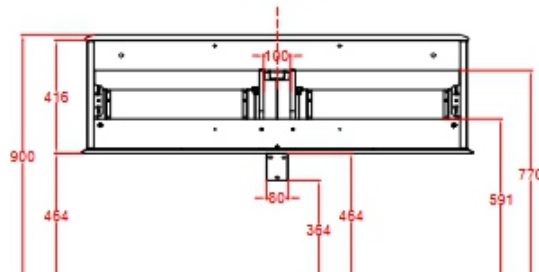
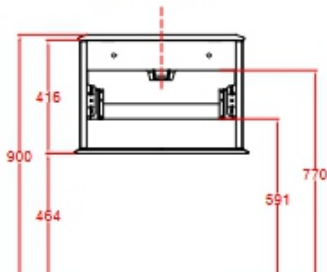

61 - 95cm

141cm

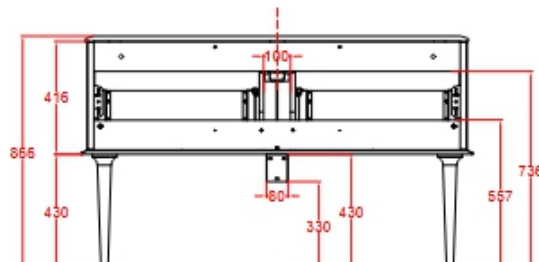
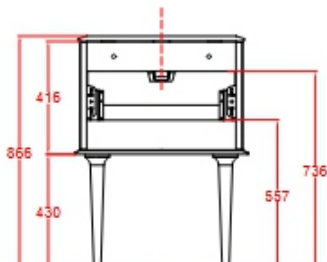
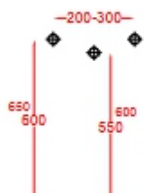

61 - 95cm

141cm

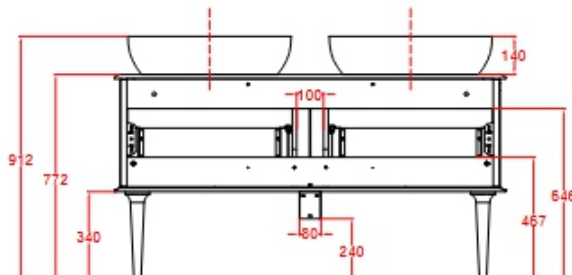

Immagine indicative

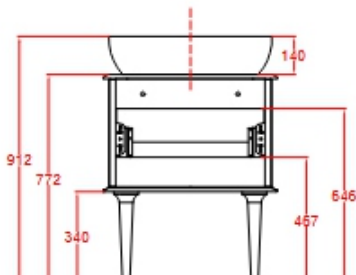
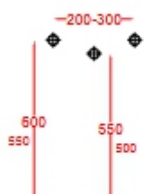
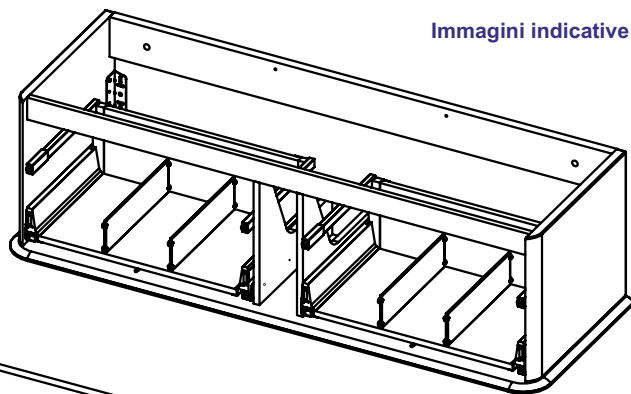
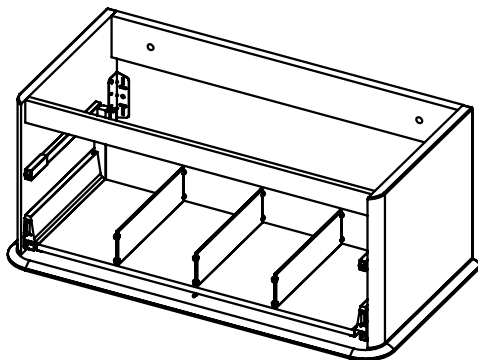
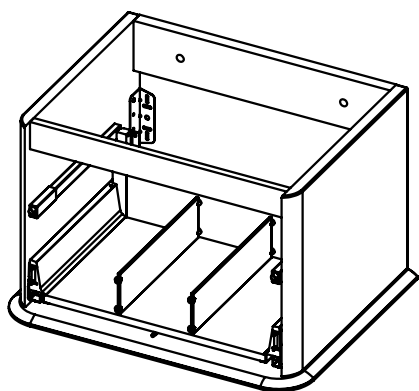

NB: Le misure riportate sono puramente indicative.

Eventuali differenze di +/- 10 mm dovute anche ad esigenze produttive NON precludono la conformità o funzionalità del prodotto. Verificare le quote con il mobile prima di realizzare gli scarichi.